

BUSTER + PUNCH

LONDON

[product.]

PULL BAR / LINEAR / SMALL

[type. **HARDWARE.**]

[knurl. **LINEAR.**]

[detail. **TORX SCREW.**]

A pull bar made from solid metal and featuring our signature, diamond-cut, linear knurl pattern. Comes complete with small solid metal discs.

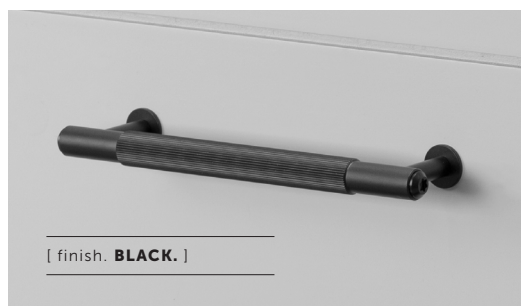

[type. **HARDWARE.**]

[info. **MEASUREMENTS.**]

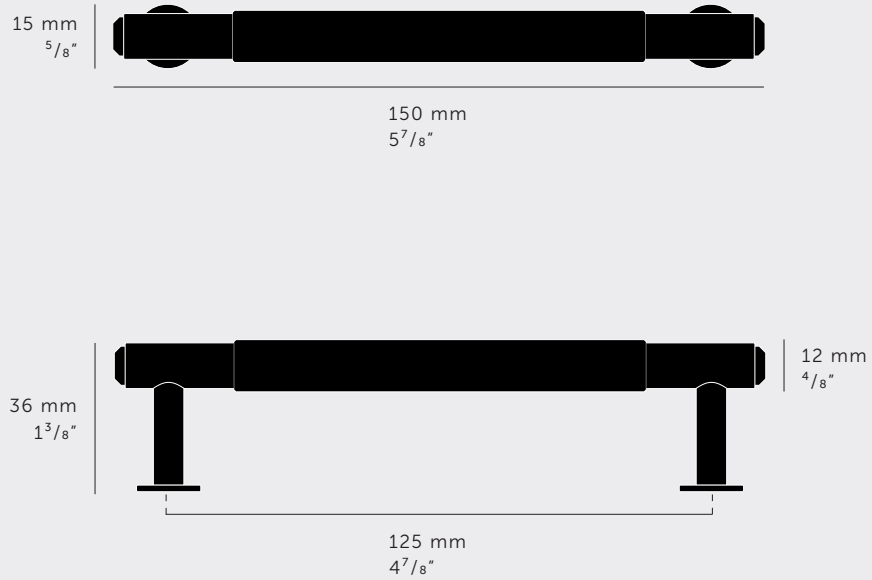

[info. **SPECIFICATIONS.**]

1 pull bar with 2 small discs

Rear fixing

Fits doors of:

Max 20mm or ²⁵/₃₂"*

*For thicker doors you will need to source longer M5 screws

[info. **FINISH & SKU NUMBERS.**]

[finish.]

[UK.]

[US.]

Steel

GPB-07285

NPB-07330

Brass

GPB-05286

NPB-05331

Gun Metal

GPB-35289

NPB-35334

Black

GPB-02288

NPB-02333

[info. **CARE INSTRUCTIONS.**]

Wipe with damp cloth with no loose hairs, avoid using any chemicals.
Please note all finishes are prone to aging.

[info. **ALSO INCLUDED.**]

2x M5 x 30 mm screws

2x M5 washers



2 pcs

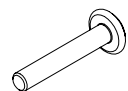

2 pcs

BUSTER+PUNCH

LONDON

[product.]

PULL BAR / LINEAR / MEDIUM

[type. **HARDWARE.**]

[knurl. **LINEAR.**]

[detail. **TORX SCREW.**]

A pull bar made from solid metal and featuring our signature, diamond-cut, linear knurl pattern. Comes complete with small solid metal discs.

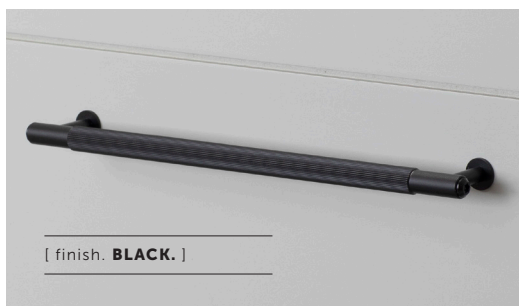

[type. **HARDWARE.**]

[info. **MEASUREMENTS.**]

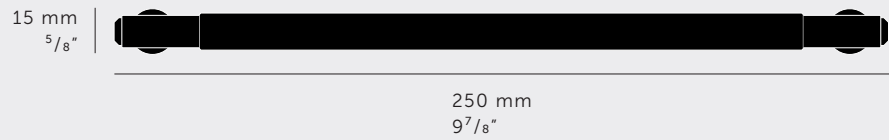

[info. **SPECIFICATIONS.**]

1 pull bar with 2 small discs

Rear fixing

Fits doors of:

Max 20mm or $25/32$ "*





*For thicker doors you will need to source longer M5 screws

[info. **FINISH & SKU NUMBERS.**]

[finish.]

[UK.]

[US.]

 Steel	GPB-07290	NPB-07335
 Brass	GPB-05291	NPB-05336
 Gun Metal	GPB-35294	NPB-35339
 Black	GPB-02293	NPB-02338

[info. **CARE INSTRUCTIONS.**]

Wipe with damp cloth with no loose hairs, avoid using any chemicals.
Please note all finishes are prone to aging.

[info. **ALSO INCLUDED.**]

2x M5 x 30 mm screws

2x M5 washers



2 pcs

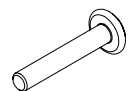

2 pcs

BUSTER + PUNCH

LONDON

[product.]

PULL BAR / LINEAR / LARGE

[type. **HARDWARE.**]

[knurl. **LINEAR.**]

[detail. **TORX SCREW.**]

A pull bar made from solid metal and featuring our signature, diamond-cut, linear knurl pattern. Comes complete with small solid metal discs.

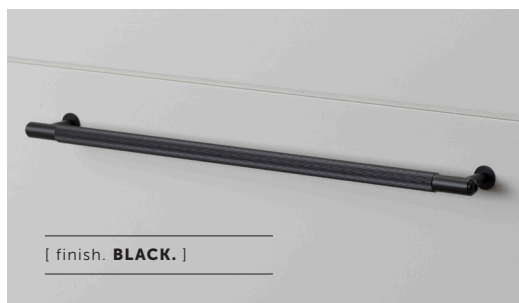

[type. **HARDWARE.**]

[info. **MEASUREMENTS.**]

15 mm
5/8"

12 mm
4/8"

350 mm
13 6/8"

325 mm
12 6/8"

[info. **SPECIFICATIONS.**]

1 pull bar with 2 small discs

Rear fixing

Fits doors of:

Max 20mm or 25/32**





*For thicker doors you will need to source longer M5 screws

[info. **FINISH & SKU NUMBERS.**]

[finish.]

[UK.]

[US.]

 Steel	GPB-07295	NPB-07340
 Brass	GPB-05296	NPB-05341
 Gun Metal	GPB-35299	NPB-35344
 Black	GPB-02298	NPB-02343

[info. **CARE INSTRUCTIONS.**]

Wipe with damp cloth with no loose hairs, avoid using any chemicals.
Please note all finishes are prone to aging.

[info. **ALSO INCLUDED.**]

2x M5 x 30 mm screws

2x M5 washers



2 pcs

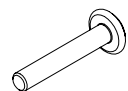

2 pcs